

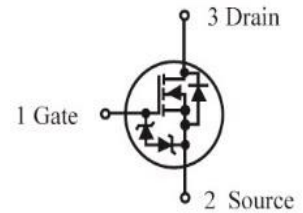

BSS139K Power MOSFET

Parameter	Symbol	Limits	Unit
Drain-Source Voltage	VDSS	50	V
Gate-to-Source Voltage – Continuous	VGS	±20	V



FEATURES

- We declare that the material of product compliance with RoHS requirements and Halogen Free.
- Low threshold voltage (VGS(th): 0.5V...1.5V) makes it ideal for low voltage applications.

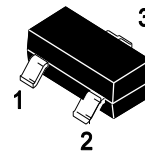

Marking J2

SOT23

THERMAL CHARACTERISTICS

Parameter	Symbol	Limits	Unit
Total Device Dissipation, FR-4 Board (Note 1) @ TA = 25°C Derate above 25°C	PD	225 1.8	mW mW/°C
Thermal Resistance, Junction-to-Ambient(Note 1)	ROJA	556	°C/W
Junction and Storage temperature	TJ,Tstg	-55~+150	°C
Maximum Lead Temperature for Solde Purposes, for 10 seconds	TL	260	°C

1. FR-4 = 1.0×0.75×0.062 in.



ELECTRICAL CHARACTERISTICS (Ta= 25 °C)

OFF CHARACTERISTICS

Characteristic	Symbol	Min.	Typ.	Max.	Unit
Drain–Source Breakdown Voltage (VGS = 0, ID = 250μA)	VBRDSS	50	-	-	V
Zero Gate Voltage Drain Current (VGS = 0, VDS = 25 V) (VGS = 0, VDS = 50 V)	IDSS	- -	- -	0.1 0.5	μA
Gate–Body Leakage Current, Forward (VGS = 20 Vdc)	IGSSF	-	-	10.0	μA
Gate–Body Leakage Current, Reverse (VGS = - 20 V)	IGSSR	-	-	-10	μA

ON CHARACTERISTICS (Note 2)

Gate Threshold Voltage (VDS = VGS, ID = 1.0mA)	VGS(th)	0.5	-	1.5	V
Static Drain–Source On–State Resistance (VGS = 2.75 V, ID < 200 mA, TA = -40°C to +85°C) (VGS = 5.0 V, ID = 200 mA)	RDS(on)	- -	5.6 -	10 3.5	Ohms
Forward Transconductance (VDS = 25 V, ID = 200 mA, f = 1.0 kHz)	gfs	100	-	-	mS

DYNAMIC CHARACTERISTICS

Input Capacitance (VDS = 25 V, VGS = 0, f = 1.0 MHz)	Ciss	-	22.8	-	pF
Output Capacitance (VDS = 25 V, VGS = 0, f = 1.0 MHz)	Coss	-	3.5	-	pF
Reverse Transfer Capacitance (VDS = 25 V, VGS = 0, f = 1.0 MHz)	Crss	-	2.9	-	pF

SWITCHING CHARACTERISTICS

Turn-On Delay Time	(VDD = 30 V , VGEN = 10 V, RG =25Ω ,RL =60 Ω, ID =500 mA)	td(on)	-	3.8	-	ns
Turn-Off Delay Time		td(off)	-	19	-	

2.Pulse Test: Pulse Width ≤300 μs, Duty Cycle ≤2.0%.



ELECTRICAL CHARACTERISTICS CURVES

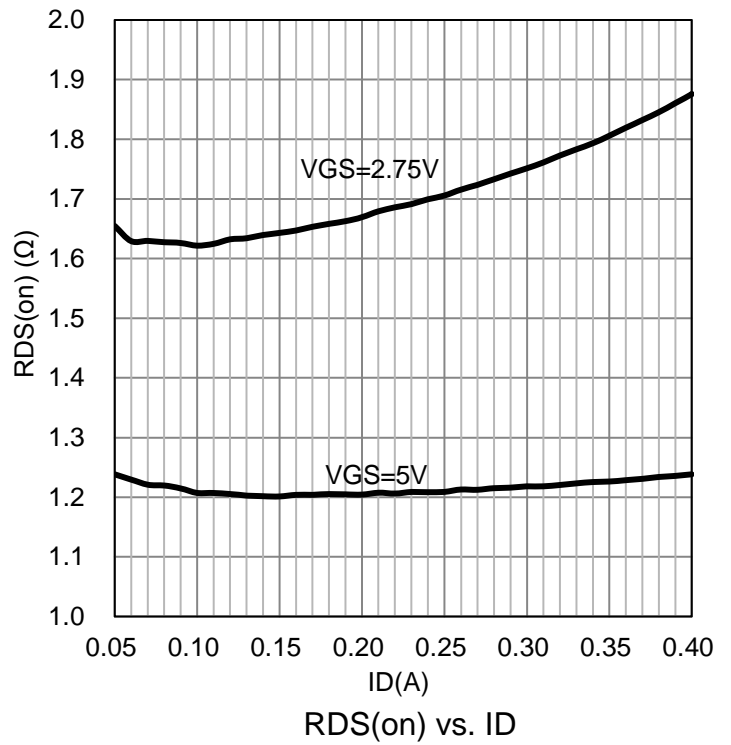
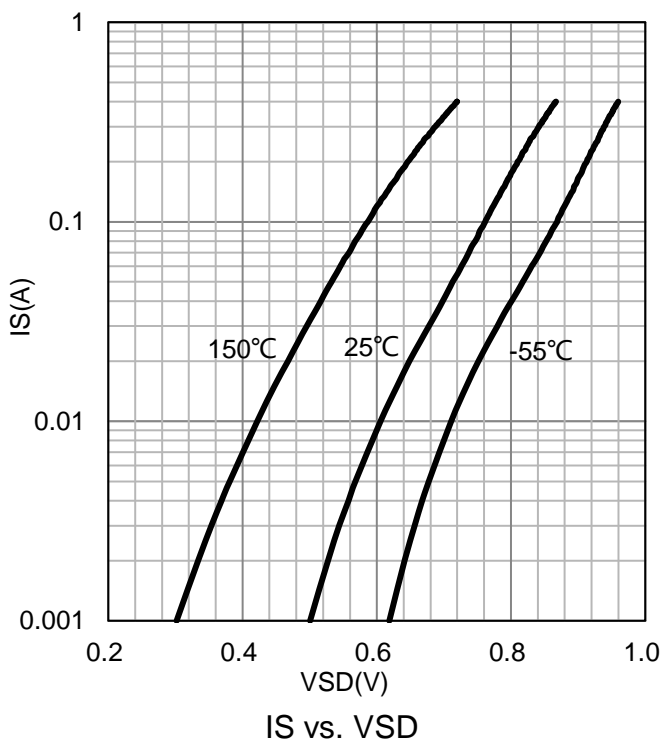
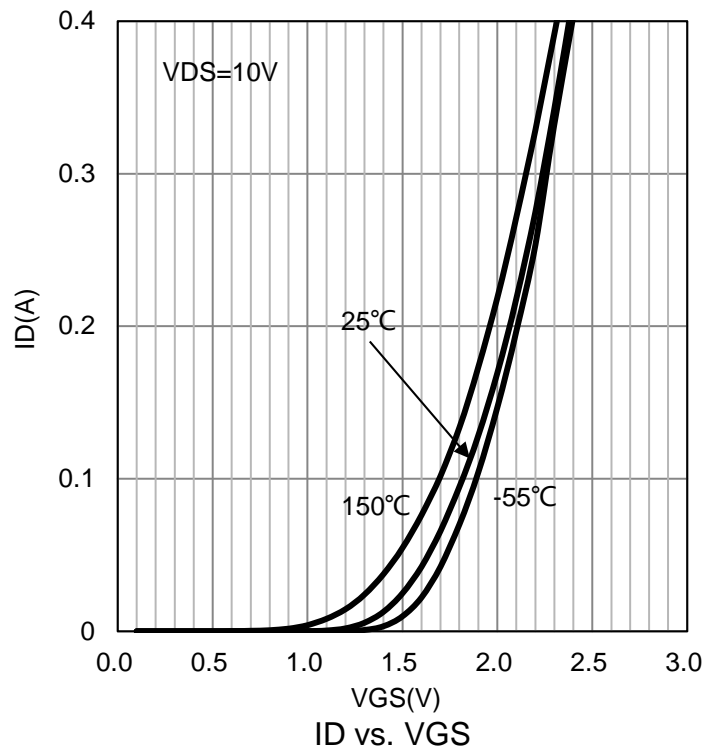
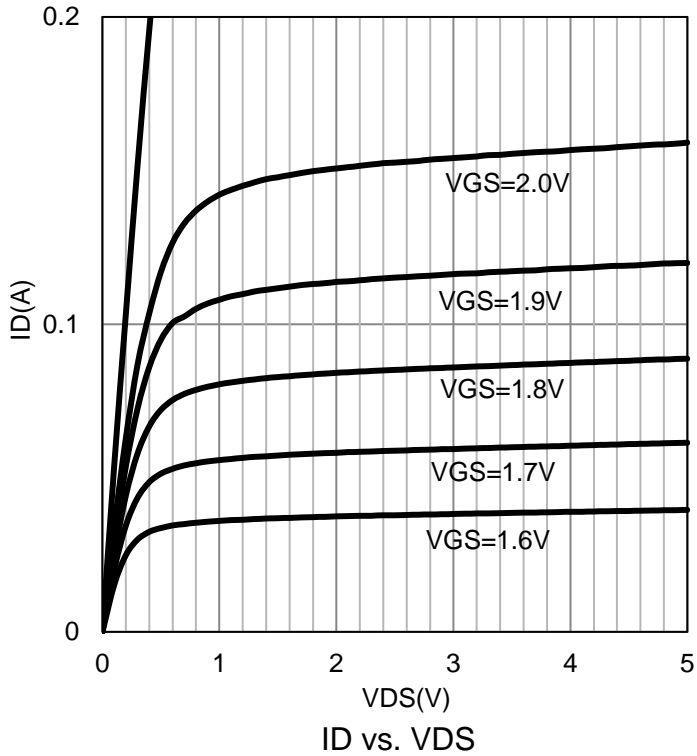

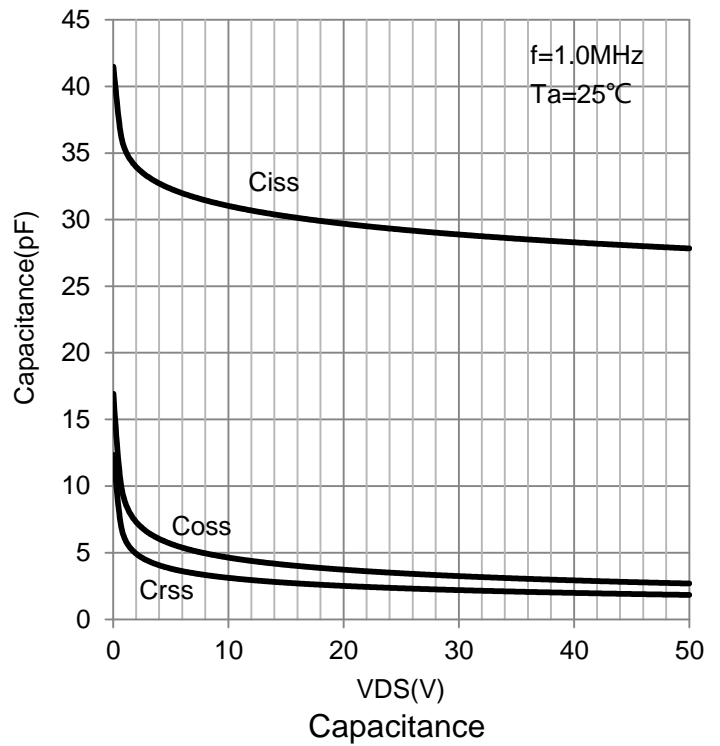
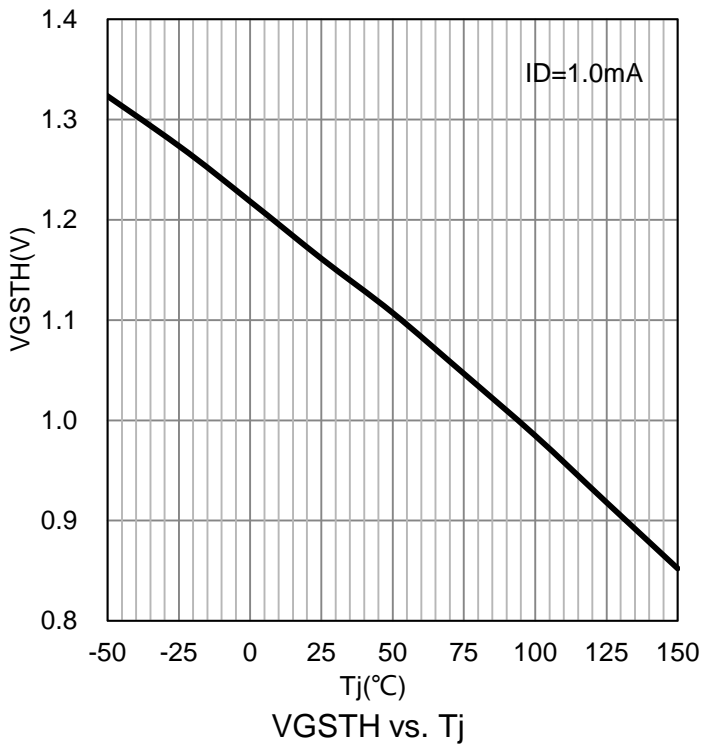
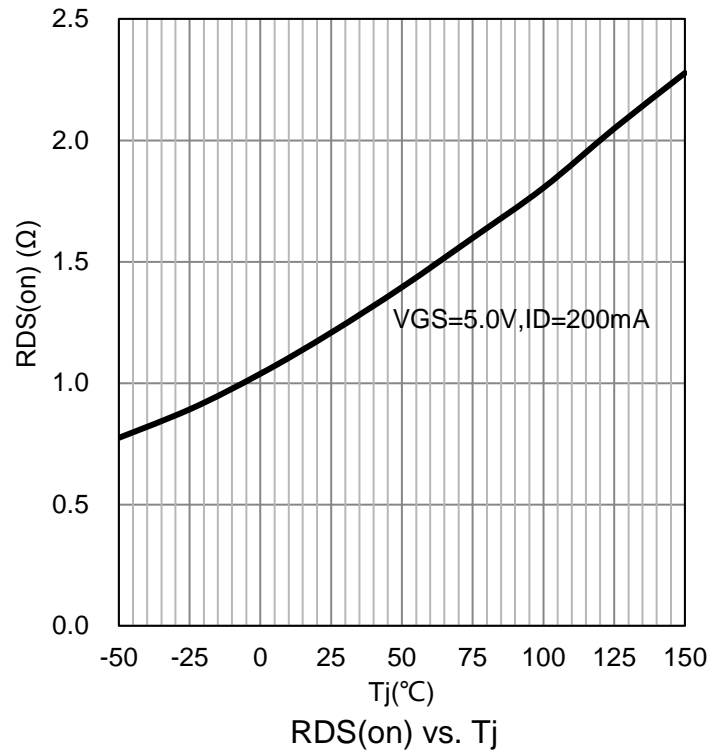
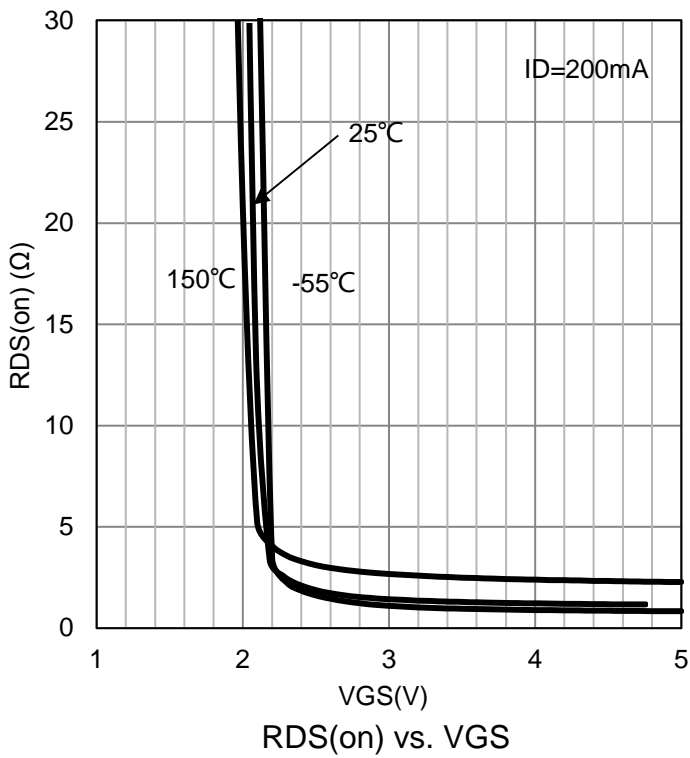



PACKAGE OUTLINE

Plastic surface mounted package; 3 leads

SOT-23

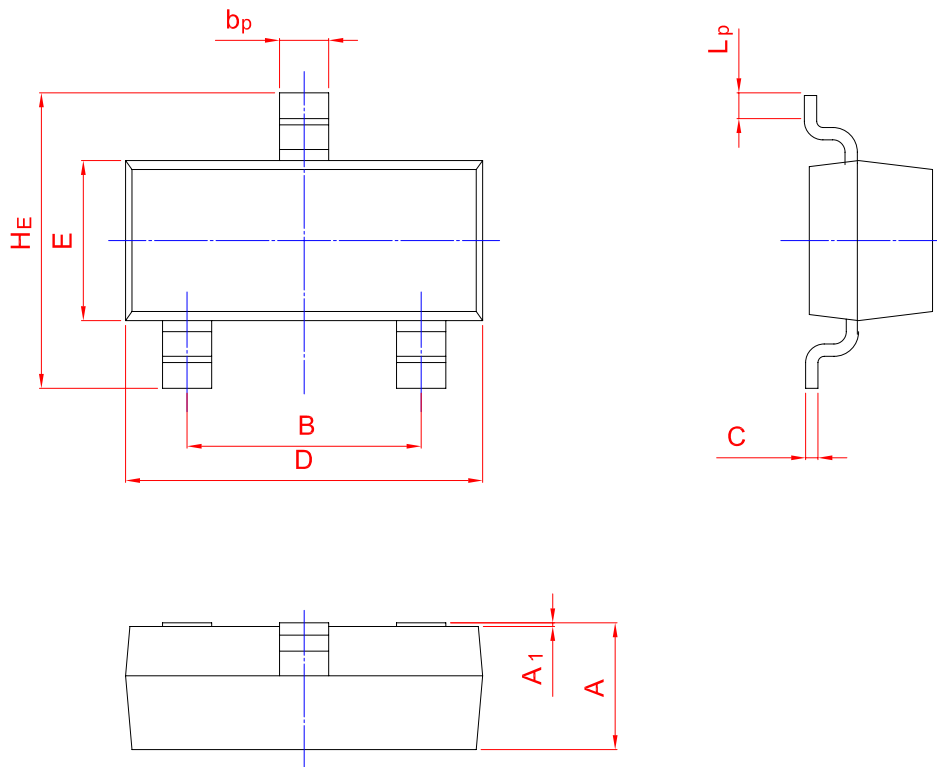
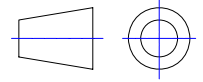

UNIT	A	B	bp	C	D	E	HE	A1	Lp
mm	1.40	2.04	0.50	0.19	3.10	1.65	3.00	0.100	0.50
	0.95	1.78	0.35	0.08	2.70	1.20	2.20	0.013	0.20